

Ewo

Flood light

(Wattage & CCT Changeable)



Features

- PET reflector for high lumen efficacy of 135lm/w
- Comfortable lighting effect and effectively glare control by adopting newly designed frosted diffuser
- Optional to equip with infrared sensor for intelligent power saving
- Equipped with 6KV SPD for better protection under extreme power condition



Flood



IP Rating
IP66



IK Rating
IK08



Standard Warranty

TECHNICAL DATA SHEET - EWO - 18408 - FLOOD LIGHT



TECHNICAL DATA

Product Data	Flood Light
Lamp Type	LUMILED's
Wattage	80W/100W/120W
Color Temperature	3000K/4000K/5000K
Rated Luminaire Efficiency	140lm/W
IP Rating	66
Beam Angle	120°
Voltage	AC220-240V
Frequency Range	50-60 Hz
CRI	Ra>70
Power Factor	>0.95
SDCM	<5
IK Rating	08
Operating Temperature	-45 °C to +45 °C
Surge	6KV
Safety Class	Class I
Material	Die cast aluminium body
Lens	Tempered glass
Finish	Black
Life Span	50,000 Hours
Warranty	5 Years
Applications	Outdoors, Commercial, Hospitality etc.

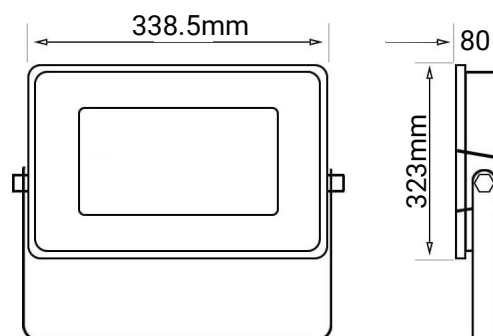
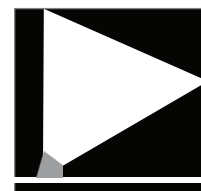
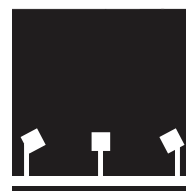
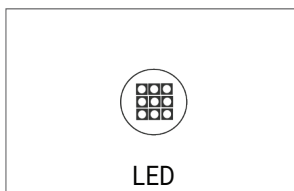

TECHNICAL OPTIONS

Wattage	150W/180W/200W
Control	Switchable, TRIAC, 1-10V, DALI
Installation	U bracket Mount, Trunion, Slip Fitter, Knuckle

TECHNICAL DATA SHEET - EWO - 18408 - FLOOD LIGHT

PRODUCT FEATURES & BENEFITS

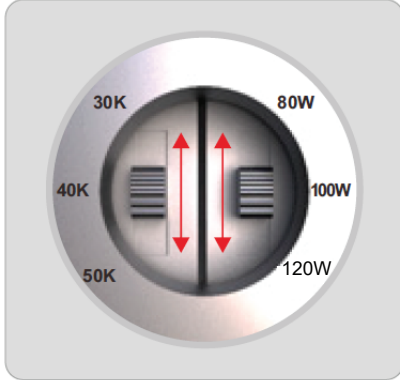

Multi-CCT & Multi-Wattage Switchable
80W/100/120W
3000K-4000K-5000K



Slim & Sturdy One-piece
Die Cast Aluminum Housing

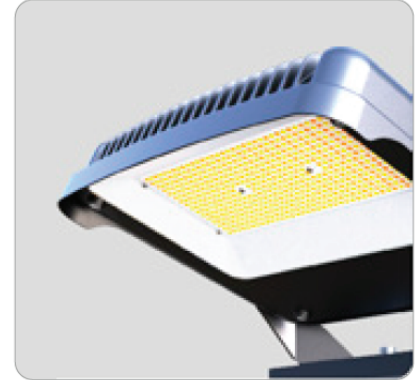

Integrated Visor Reduces
Observable Glare

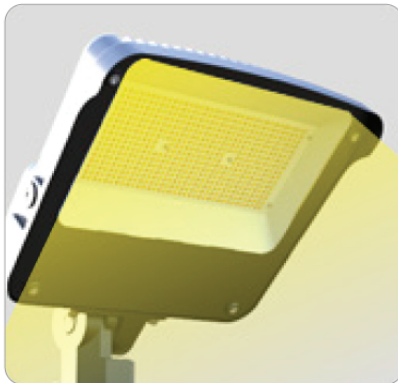

High Efficacy Up to 140LPW



High-reflectance white reflector

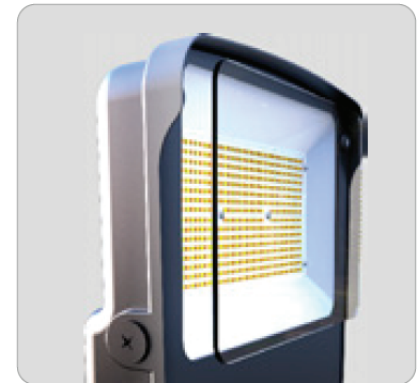

Tempered glass lens won't yellow



Photocell