

Amara

Surface Mounted light (Changeable CCT)



Features

- Amara creates extreme low heat and offers an excellent lumen performance
- Energy saving up to 85%, high efficiency power supply, low power consumption
- High value appearance and durability
- Easy to install

 Surface

 IP Rating
IP44

 UGR
<19

 6 years
warranty Standard Warranty

TECHNICAL DATA SHEET - AMARA - 18913 - SURFACE MOUNTED LIGHT



TECHNICAL DATA

Product Data	Surface Mounted light
Lamp Type	BRIDGELUX LED
Wattage	10W
Color Temperature	3000K/4000K/6000K
Rated Luminaire Luminous Flux	700lm,750lm,800lm
Rated Luminaire Efficiency	70lm/W/75lm/W/80lm/W
IP Rating	44
Beam Angle	60°
Input Voltage	AC220-240V
Output Voltage	DC36V
Frequency Range	50-60 Hz
CRI	Ra>90
Power Factor	>0.5
Current	300mA
Safety Class	Class II
Operating Temperature	-20°C ~ +40°C
SDCM(MacAdam)	< 3
Material	Die cast Aluminium+PC body
Finish	Sanded White+Black
Life Span	60,000 Hours
Warranty	6 Years
Applications	Residential, Commercial, Hospitality etc.

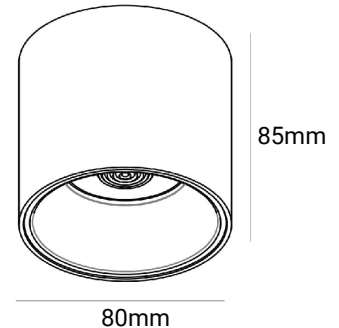
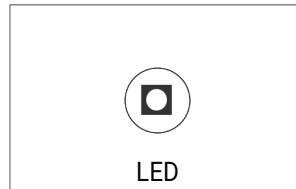

TECHNICAL OPTIONS

Wattage	20W
Beam Angle	36°
Finish	Black
Control	Switchable/TRIAC/0-10V/DALI/1-10V